

## NEVA SURFACE

### D93164

PROJECT	
TYPE	
NOTES	
QUANTITY	
DATE	

#### GENERAL

Series: Neva
Brand: Milan
Division: Design
Mounting Type: Surface
Mounting Location: Wall
Subcategory: Uplight

#### PHYSICAL

Shape: Rectangle
Length (mm): 128
Length (in): 5 1/16"
Height (mm): 85
Height (in): 3 3/8"
Extension (mm): 117
Extension (in): 4 5/8"
Light Distribution: Direct / Indirect
Weight (kg): 1.4
Weight (lbs): 3
Fixture Finish: SST
Fixture Material: Metal

#### ELECTRICAL

Number of Lamps: 1
Lamp Type: LED
Max. Wattage Per Lamp (W): 10
Dimming: Non-Dimmable
Driver Included: Yes
Driver Location: Integrated
Driver Type: Constant Current
Driver Class: Class 2
Housing: ENCP3
Input Voltage (V): 120
Upon Request: Dimmable option available with remote driver upon request

#### LED

Number of LEDs: 1
Color Temperature (°K): 2700
Max. Delivered Lumen (lm): 642.97
Nominal Lumen (lm): 1010
CRI: >80 CRI

#### OPTICAL

Reflector°: 50
----------------

#### RATINGS AND CERTIFICATIONS

Certified By: CSA Certified to UL and CSA Standards
IP rating: IP20

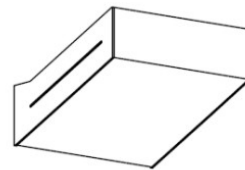

128mm 5 1/16"

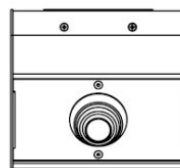

108mm 4 1/4"

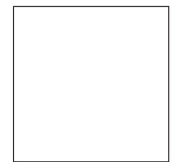

108mm 4 1/4"

J-Box cover plate  
Included



85mm 3 3/8"

117mm 4 5/8"



## NEVA SURFACE

### D93165

PROJECT
TYPE
NOTES
QUANTITY
DATE

#### GENERAL

Series: Neva  
 Brand: Milan  
 Division: Design  
 Mounting Type: Surface  
 Mounting Location: Wall  
 Subcategory: Uplight

#### PHYSICAL

Shape: Rectangle  
 Length (mm): 128  
 Length (in): 5 1/16  
 Height (mm): 85  
 Height (in): 3 3/8  
 Extension (mm): 117  
 Extension (in): 4 5/8  
 Light Distribution: Direct / Indirect  
 Weight (kg): 1.4  
 Weight (lbs): 3  
 Fixture Finish: WHI  
 Fixture Material: Metal

#### ELECTRICAL

Lamp Type: LED  
 Max. Wattage Per Lamp (W): 10  
 Dimming: Non-Dimmable  
 Driver Included: Yes  
 Driver Location: Integrated  
 Driver Type: Constant Current  
 Driver Class: Class 2  
 Housing: ENCP3  
 Input Voltage (V): 120  
 Upon Request: Dimmable option available with remote driver upon request

#### LED

Number of LEDs: 1  
 Color Temperature (°K): 2700  
 Nominal Lumen (lm): 1010  
 CRI: >80 CRI

#### OPTICAL

Reflector°: 50

#### RATINGS AND CERTIFICATIONS

Certified By: CSA Certified to UL and CSA Standards  
 IP rating: IP20

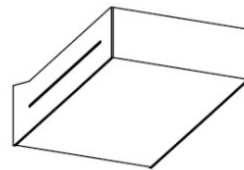

128mm 5 1/16"

108mm 4 1/4"

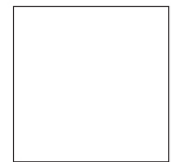

108mm 4 1/4"

J-Box cover plate  
Included



85mm 3 3/8"

117mm 4 5/8"

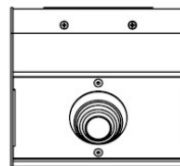

## NEVA SURFACE

### D93166

PROJECT	
TYPE	
NOTES	
QUANTITY	
DATE	

#### GENERAL

Series: Neva  
 Brand: Milan  
 Division: Design  
 Mounting Type: Surface  
 Mounting Location: Wall  
 Subcategory: Uplight

#### PHYSICAL

Shape: Rectangle  
 Length (mm): 253  
 Length (in): 9 <sup>15</sup>/<sub>16</sub>"  
 Height (mm): 85  
 Height (in): 3 <sup>3</sup>/<sub>8</sub>"  
 Extension (mm): 117  
 Extension (in): 4 <sup>5</sup>/<sub>8</sub>"  
 Light Distribution: Direct / Indirect  
 Weight (kg): 1.8  
 Weight (lbs): 4  
 Fixture Finish: SST  
 Fixture Material: Metal

#### ELECTRICAL

Lamp Type: LED  
 Total Output Wattage (W): 20  
 Max. Wattage Per Lamp (W): 10  
 Dimming: Non-Dimmable  
 Driver Included: Yes  
 Driver Location: Integrated  
 Driver Type: Constant Current  
 Driver Class: Class 2  
 Housing: ENCP3  
 Input Voltage (V): 120  
 Upon Request: Dimmable option available with remote driver upon request

#### LED

Number of LEDs: 2  
 Color Temperature (°K): 2700  
 Nominal Lumen (lm): 2020 (2x1010lm)  
 CRI: >80 CRI

#### OPTICAL

Reflector: 2 x 50°

#### RATINGS AND CERTIFICATIONS

Certified By: CSA Certified to UL and CSA Standards  
 IP rating: IP20

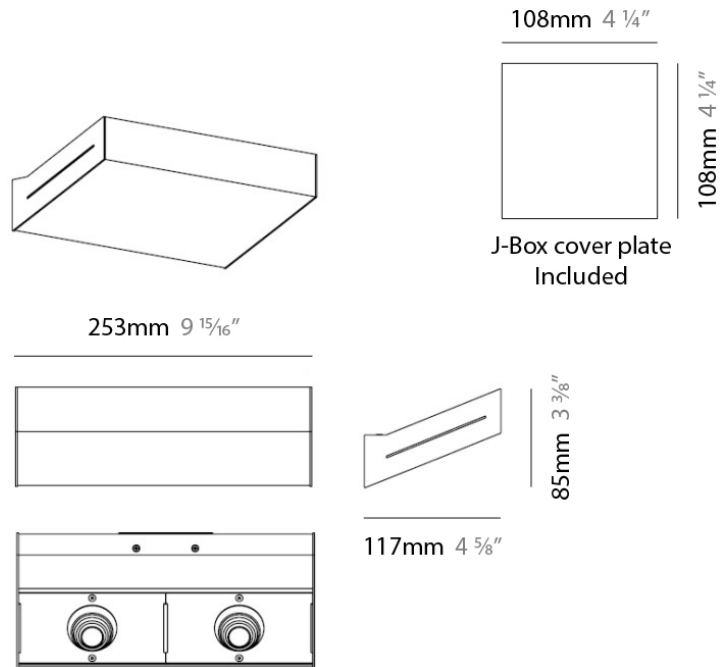

## LEGEND

	floor-mounted		pivotal		special LED (upon request) RGB, RGBW, tunable, gold+, meat+, art+, fashion+
	wall and ceiling: recessed and surface mounted		rotating		warm dim / natural dimming LED
	ceiling-mounted and wall-mounted		illuminate tilted		rechargeable battery powered
	wall-mounted		color of suspension cable		fixture with natural vivid LED (upon request)
	omni-directional light distribution		length of suspension cable		color rendering index
	direct light distribution		reflector degree selection		color temperature
	direct/indirect light distribution		super spot		lumen (luminous flux)
	indirect light distribution		lens		efficacy (lumens per watt)
	asymmetric light distribution		lens pack		Unified Glare Rating (UGR) range from 5-40
	aura light distribution		shine ring		marine grade (AISI 316 stainless steel)
	round wall or ceiling cut-out		integrated shine ring with diffuser		walk on
	square wall or ceiling cut-out		free individual colors 01-29		drive on
	the supplied jig specifies the cutout dimensions		individual colors: 00 (free of charge), 01-25 (extra charge)		Dark Sky Compliance
	minimum distance (meters) lamp - object		luminaire part to be colored (F1)		Americans with Disabilities Act (less than 4" off the wall located between 27"-84" from floor)
	recessed depth		luminaire part to be colored (F2)		lamp protected against explosion
	ceiling thickness in mm		luminaire part to be colored (F3)		blown glass using traditional methods by master glass blower
	ceiling thickness selection		luminaire part to be colored (F4)		acoustic material
	dimmable DP (phase), DV (0-10V), DD (dali), DS (step-dim)		luminaire part to be colored (F5)		protection class I, protection insulation
	included or excluded LED driver/transformer/control gear		color of 3-circuit adaptor		protection class II, protection insulation
	separately switchable		indirect diffuser		ETL Certified to UL and CSA Standards
	sensor		direct diffuser		UL Certified to UL and CSA Standards
	remote control		ball-proof (upon request)		CSA Certified to UL and CSA Standards
	available upon request		accessory		Certified for North American Standards

## IP RATING

	protected against ingress of solid bodies greater than 12.5mm (finger)
	protected against ingress of solid bodies greater than 2.5mm protected against sprays of water up to 60 degrees from the vertical (rain)
	protected against ingress of solid bodies greater than 1mm (wire) no protection against the ingress of moisture
	protected against ingress of solid bodies greater than 1mm (wire) protected against sprays of water up to 60 degrees from the vertical (rain)
	protected against ingress of solid bodies greater than 1mm (wire) protected against water splashed from all directions
	protected against limited ingress of dust (wet rooms/covered outdoor areas) protected against water splashed from all directions
	protected against ingress of dust protected against jets of water
	protected against ingress of dust protected against powerful jets of water or heavy seas
	protected against ingress of dust protected against immersion of water between 15cm - 1m for 30 minutes
	protected against ingress of dust protected against immersion of water under pressure for long periods

## IK RATING

	protected against 0.14 joules impact (equivalent to 0.25kg mass dropped from 56mm above the surface)
	protected against 0.2 joules impact (equivalent to 0.25kg mass dropped from 80mm above the surface)
	protected against 0.35 joules impact (equivalent to 0.25kg mass dropped from 140mm above the surface)
	protected against 0.5 joules impact (equivalent to 0.25kg mass dropped from 200mm above the surface)
	protected against 0.7 joules impact (equivalent to 0.25kg mass dropped from 280mm above the surface)
	protected against 1 joules impact (equivalent to 0.25kg mass dropped from 400mm above the surface)
	protected against 2 joules impact (equivalent to 0.5kg mass dropped from 400mm above the surface)
	protected against 5 joules impact (equivalent to 1.7kg mass dropped from 300mm above the surface)
	protected against 10 joules impact (equivalent to 5.0kg mass dropped from 200mm above the surface)
	protected against 20 joules impact (equivalent to 5.0kg mass dropped from 400mm above the surface)